

Overview and Identification

BAPI recommends fiber optic cable for HVAC communications networks that travel between buildings. Fiber optic cable is not electrically conductive therefore it is not affected by electrical disturbances such as lightning strikes, radio transmitters or system ground variations.

The FOX Communication Kit (BA/FOX-KIT) provides all the functions for one fiber optic and remote RS-485 network, plus it comes in a self-contained, easy-to-apply and cost effective assembly.

The kit also aids in troubleshooting because LEDs indicate when power is applied and communications are present.

The FOX Communications Kit includes:

- One FOX Fiber Optic Transceiver module which converts RS-485 data to a fiber optic signal or converts a fiber optic signal to RS-485 data;
- A VC350A 350mA voltage converter to provide the higher current necessary for flawless communications;
- A SRBP Single Repeater Back Plane to mount the FOX Module and provide pluggable connectors for power and three RS-485 cables;
- A four inch long piece of 2.75" snaptrack to easily mount the entire assembly.

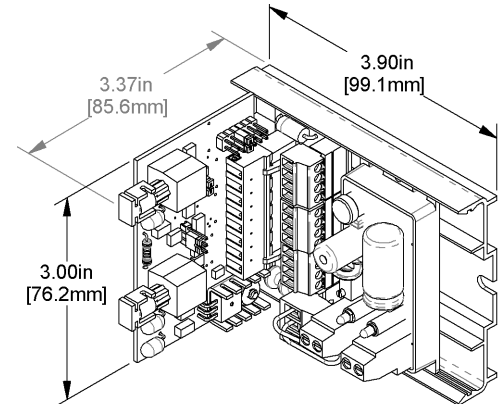

Fig. 1: FOX Communication Kit

Tools & Materials

Drill, Drill Bits, 2-#8 screws, Large Screw Driver, Small Screw Driver (BA/116W), Wire, 24VAC Class 2 Transformer, Optional Wall Anchors

Notes on RS-485

RS-485 defines a half duplex bidirectional data network. Many transmitters and receivers can be connected to the RS-485 network, but only one transmitter can operating at any given time.

A frequent question is "How many RS485 devices can I put on the network at one time?" The RS-485 standard does not answer this question directly; it says that each transceiver must be able to drive 32 Unit Loads. Most folks come to the natural conclusion that the network can only support 32 devices.

RS-485 devices may have one unit load or a fractional unit load. Typical numbers are 1, 1/4 and 1/8. The number of RS-485 Unit Loads for any RS-485 device will be available from the device manufacturer. Total all the unit loads on an RS-485 network and be sure to stay under 32.

Example: For an RS-485 network you need a RPTR Module, a FOX Module and a bunch of other devices. After investigating you find out that: BAPI's RPTR Module and FOX Module each have a unit load of 1; 20 devices have a 1/4 unit load each and 56 devices have a 1/8 unit load each. The number of Unit Loads on the network is:

$1 + 1 + (20 \times 1/4) + (45 \times 1/8) = 1 + 1 + 5 + 7 = 14$ Unit Loads. Since 14 is less than 32, the network is not overloaded.

Mounting

The FOX Communication Kit mounts in the Snaptrack provided. Hold the FOX Kit against the surface you want to mount on. Mark the mounting slots on each end of the snap track.

Drill holes for your mounting screws or wall anchors. If you are using wall anchors insert them into the holes. Start one of the mounting screws leaving enough of the screw protruding to slip the snap track under it.

Slip the FOX Kit under the screw and line up with the hole for the second mounting screw. Insert the second screw into its hole and screw all the way down. Screw the first screw all the way down.

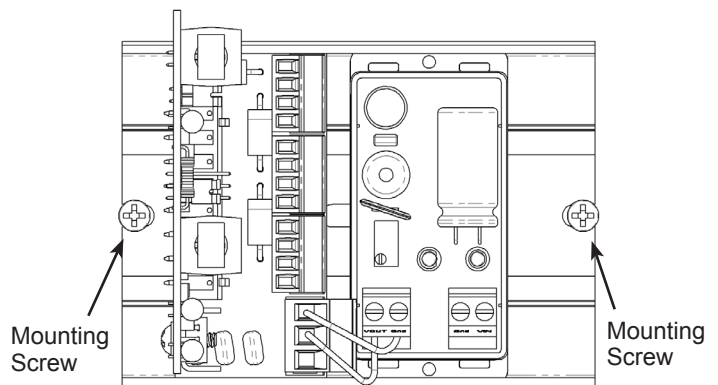

Fig. 2: FOX Communication Kit Mounting

Specifications subject to change without notice.

Termination

FOX Module Termination, Fig. 3

Select the baud rate by moving the jumper to the system data rate. Remove the dust covers and connect the communications fiber. Plug the FOX Module into the Single Repeater Backplane as shown in Fig. 1.

Fig. 3:
FOX Module

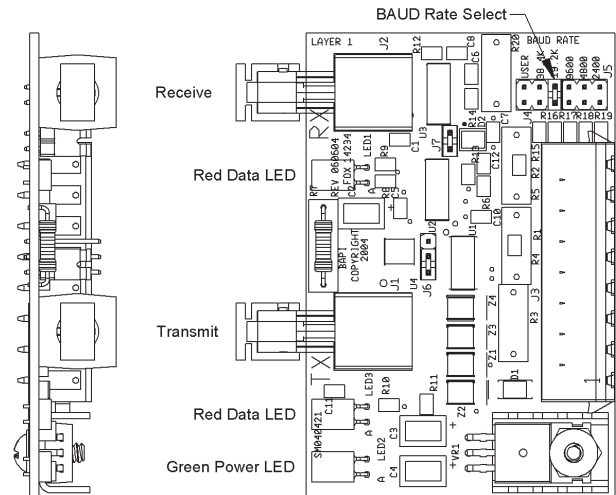

SRBP Module Termination, Fig. 4

Connector J1 is used to mount the repeater.
Connectors J2, J3, and J4 terminate the local RS-485 bus.
Connector J5 is used for power (prewired at the BAPI factory).

Fig. 4: SRBP Module Component Identifier

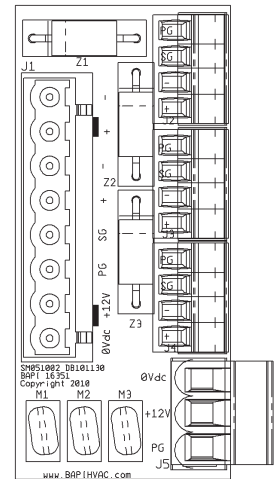

NOTE: The connectors use a rising block screw terminal to hold the wires. It is possible for the block to be in a partially up position allowing the wire to be inserted under the block. Be sure that the connector screws are turned fully counterclockwise before inserting the wire. Lightly tug on each wire after tightening to verify proper termination.

VC350A-12, Fig 5 & Fig 6

Connect ground and power terminals to a National Electric Code Class 2 transformer or DC power. The VC350A-12 Voltage Converter is half wave rectified. The VAC neutral input and the VDC GND outputs are common.

VC350 Terminal	VC350A Terminal		Function
Prior to 7/25/2011	Prior to 1/23/2013	After 1/23/2013	
2	1	VOUT	VDC out to peripheral devices
1	2	GND	VDC out ground or common
3	3	GND	VAC or VDC input ground or common
4	4	VIN	VAC or VDC input from transformer or other power supply

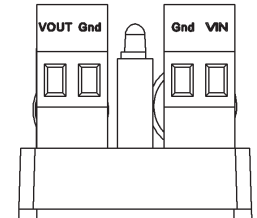
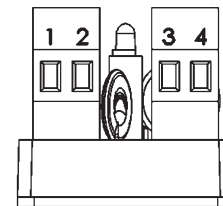

Fig 5: VC350A Terminations prior to 1/23/2013 (includes terminations of the VC350 unit prior to 7/25/2011)

Fig 6: VC350A Terminations after 1/23/2013

Note: The terminals use a rising block screw terminal to hold the wires. It is possible for the block to be in a partially up position allowing the wire to be inserted under the block. Be sure that the connector screws are turned fully counterclockwise before inserting the wire. Lightly tug on each wire after tightening to verify proper termination.

Specifications subject to change without notice.

Operation

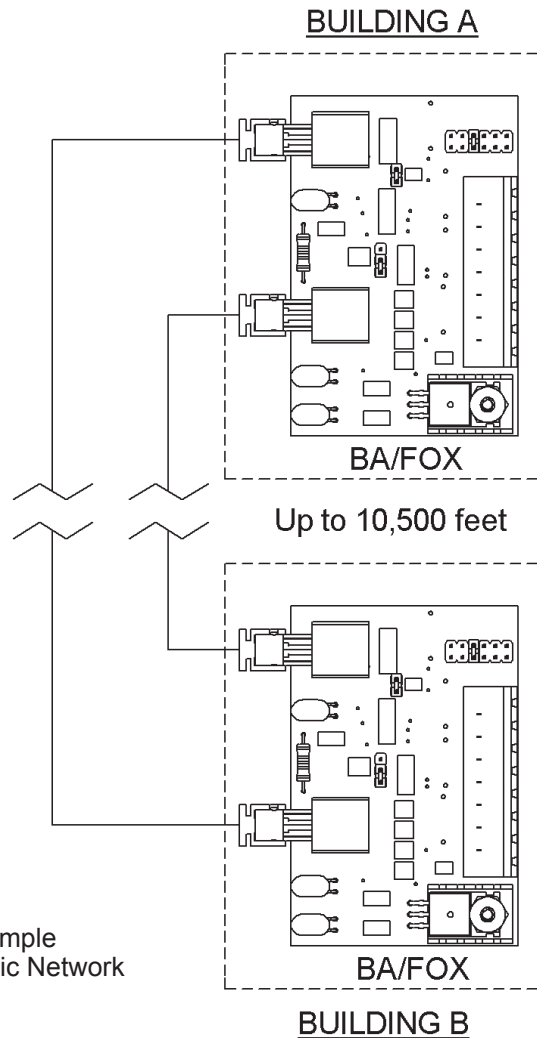

Fig. 6: Simple Fiber Optic Network

The FOX Fiber Optic Transceiver extends an RS-485 network from one building to another on non-conductive fiber optic cable. The non-conductive fiber optic cable eliminates electrical problems such as ground imbalances, lightning discharges or radio transmitter interference.

The simplest network is shown in Figure 6. Two FOXs are used to extend an RS-485 network from Building A to Building B. The transmitter of Building A's FOX is connected to the receiver Building B's FOX. The transmitter of Building B's FOX is connected to the receiver Building A's FOX. The RS-485 network data is taken from the SRBP Single Repeater Backplane connectors J2, J3, and J4.

Larger networks can be assembled using additional FOX Communication Kits as long as each FOX Communication Kit's transmitter is connected to another's receiver.

Specifications subject to change without notice.



FOX Communication Kit (BA/FOX-KIT)

Installation and Operation Instructions

18515_ins_Fox_kit

rev. 05/10/13

Diagnostics

Possible Problems:

FOX Module will not plug into backplane

Green LED on VC350A-12 does not light

Green LED on VC350A-12 is dim and output is ~1.5VDC

Power LED L1 on FOX Module does not light

Data LEDs do not blink

Data does not get through

Possible Solutions:

- Make sure that the backplane is inserted into the snaptrack in the proper orientation

- Check to see if the power to the VC350A-12 is turned on

- Load is too great, check FOX for proper operation.

- Check to see that the FOX is firmly inserted into the SRBP

- Check to see if the power connector is firmly inserted into the SRBP

- Check to see if the VC350A-12 is working correctly

- Check to see if the power to the VC350A-12 is turned on

-Check Optical communications link for proper termination

-Check RS-485 communications link for proper termination

-Check to see if Baud rate jumper is properly set

-Check RS-485 communications link for number of unit loads. Must be below 32.

Specifications

Communications Rates: 2400, 4800, 9600, 19.2K, and 38.4K Baud

Network Load: 1 unit on RS-485 network

Network Length: 4000ft (1.2Km, RS-485)
6560ft (2Km, optical network)

Input Voltage: 18 to 30 VAC, 24 VDC

Input Current Max: 760 mA AC (18.25 VA), 400 mA DC

Specifications subject to change without notice.