

Overview and Identification

The BAPI-Stat is a multiple output transmitter for temperature and humidity with setpoint capability for both and occupied/unoccupied override switching.

The large easy-to-read display is ideal for cross room viewing and membrane push buttons are designed for easy operation and cleaning.

A fully featured unit can have 4 active channel outputs, override and a passive sensor output. All ranges are factory set, however each temperature and humidity sensor channel has a local offset adjust for fine tuning. The display can be locally customized to the customer's preference.

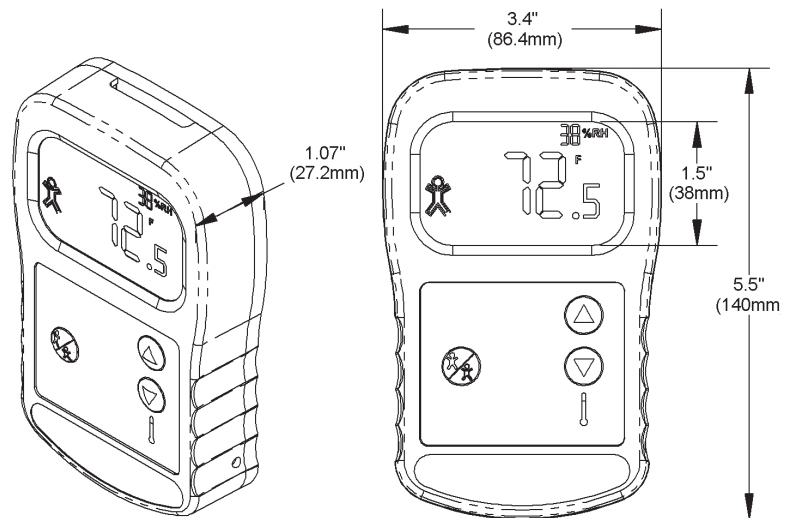

Fig. 1: 3 Button BAPI-Stat

Specifications

Power Supply:	10 to 35 VDC (15 to 24 VDC Recommended) for 4 to 20 mA or 0 to 5 VDC Outputs 15 to 35 VDC (15 to 24 VDC Recommended) for 0 to 10 VDC Outputs 12 to 28 VAC (Requires a separate pair of shielded wires) for 4 to 20 mA or 0 to 5 VDC Outputs 15 VAC to 28 VAC (Requires a separate pair of shielded wires) 0 to 10 VDC Output
Power Consumption:	60 mA maximum DC: 4 to 20 mA or 0 to 5 VDC Outputs 10 mA maximum DC: 0 to 10 VDC Output 1.44 VA maximum AC: 4 to 20 mA or 0 to 5 VDC Outputs 0.2 VA maximum AC: AC: 0 to 10 VDC Output
Sensing Elements:	Temperature - Thermistor RTD or Semiconductor Humidity - Capacitive Polymer, $\pm 2\%$ RH
Mounting:	2" by 4" J-box or drywall mount - screws provided
Ambient Specifications:	Temperature: 32 to 122°F (0 to 50°C) Humidity: 0 to 95%, non-condensing
Wiring:	2 to 5 pair of 16 to 22 AWG
Material:	ABS Plastic
Material Rating:	UL 94, V-0

Specifications subject to change without notice.

Mounting

JUNCTION BOX

1. Pull the wire through the wall and out of the junction box, leaving about six inches free.
2. Pull the wire through the hole in the base plate.
3. Secure the backplate to the box using the #6-32 x 1/2 inch mounting screw provided.
4. Terminate the unit according to the guidelines in the **Termination** section.
5. Attach Cover by latching it to the top of the base, rotating the cover down and snapping it into place.
6. Secure the cover by backing out the lock-down screws using a 1/16” allen wrench until they are flush with the bottom of the cover.

DRYWALL MOUNTING

1. Place the base plate against the wall where you want to mount the sensor.
2. Using a pencil, mark out the two mounting holes and the area where the wires will come through the wall.
3. Drill two 3/16” holes in the center of each marked mounting hole. Insert a drywall anchor into each hole.
4. Drill one 1/2” hole in the middle of the marked wiring area.
5. Pull the wire through the wall and out the 1/2” hole, leaving about six inches free.
6. Pull the wire through the hole in the base plate.
7. Secure the base to the drywall anchors using the #6 x 1” mounting screws provided.
8. Terminate the unit according to the guidelines in the **Termination** section.
9. Attach cover by latching it to the top of the base, rotating the cover down and snapping it into place.
10. Secure the cover by backing out the lock-down screws using a 1/16” allen wrench until they are flush with the sides of the cover.

Note: In any wall-mount application, the wall temperature and the temperature of the air within the wall cavity can cause erroneous readings. The mixing of room air and air from within the wall cavity can lead to condensation, erroneous readings and sensor failure. To prevent these conditions, BAPI recommends sealing the conduit leading to the junction box with fiberglass insulation.

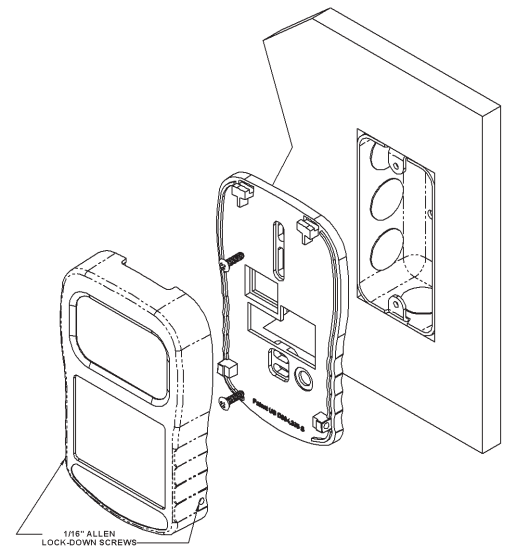

Fig. 2:

Mounting hardware is provided for both junction box and drywall installation (junction box installation shown).

Front Panel Description

When the ▲ or ▼ buttons are pressed, the temperature setpoint will display, then as the buttons are pressed again the display will change in one degree increments with each press.

Pressing and holding either button will auto increment/decrement the setpoint value.

The setpoint will change only within the specified range (as ordered).

When the  button is pressed, the Occupied/Unoccupied Icon  will show for a few seconds.

To retain the Occupied/Unoccupied Icon , you must energize J6*.

(*For more information on Occupied/Unoccupied Icon, see the “Termination” and the “Display Occupancy Mode Termination” sections)

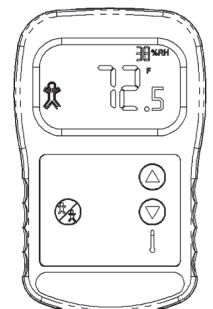

Fig. 3:
Front View of
BAPI-Stat

Specifications subject to change without notice.

Termination

BAPI recommends using twisted pair of at least 22 AWG. Larger gauge wire may be required for long runs. All wiring must comply with the National Electric Code (NEC) and local codes. **Do NOT** run this device's wiring in the same conduit as AC power wiring of NEC class 1, NEC class 2, NEC class 3 or with wiring used to supply highly inductive loads such as motors, contactors and relays. BAPI's tests show that fluctuating and inaccurate signal levels are possible when AC power wiring is present in the same conduit as the signal lines.

BAPI recommends wiring the product with power disconnected. Proper supply voltage, polarity, and wiring connections are important to a successful installation. Not observing these recommendations may damage the product and will void the warranty.

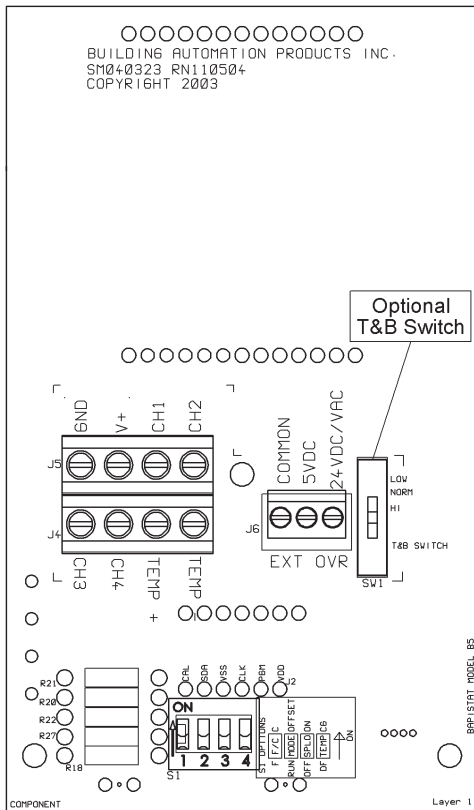

Fig. 4: BAPI-Stat Circuit Board

Terminal Notes Related to Table 1. [] = Terminal designation

1. Only one variable and output type per channel. [CH3] and [CH4] can be overridden.
2. The [GND] terminal is always the reference for [V+], [CH1] and [CH2] terminals.
3. The temperature output range is limited to between 32° to 158°F (0° to 70°C).
4. Humidity setpoint range is limited between 0-100% RH.
5. The override is available on [CH3], [CH4] and [TEMP+/TEMP-] only.
6. Voltage outputs are limited to between 0-10 VDC and are only referenced to [GND].
7. Current outputs are limited to between 0-20 mA and are only referenced to [GND].
8. Resistive E-POT outputs are limited to a 1 K, 10 K, 50 K or 100 KΩ linier POT, ±30%.
9. Resistive sensor [TEMP+/TEMP-] outputs may be any BAPI passive or solid state sensor.
10. When using a 592/334 sensor, [TEMP+] is the supply (5 to 30 VDC) [TEMP-] is the current output to the analog input @ 1µA/°C and requires S1-4 to be set for (DF). Reversal of the power will damage the sensor.
11. The Test & Balance option (-TB) cannot be used with the 592/334 sensor.
12. If the BAPI-Stat has the external sensor option (-EXT), then it must be a 10K-2 thermistor purchased separately. The external sensor is wired to the temp + and temp - terminals. A humidity signal or passive sensor are not allowed in this configuration.

Table 1: Termination Table

Terminal Name	Input Power		Output Variable (See your unit label for your configuration)					Output Signal (See your unit label for your configuration)					
	Supply Power	Internal Grounding CG=Com. GND DF=Isolated	Temperature Output	Humidity Output	Temperature Setpoint Output	Humidity Setpoint Output	Override Output	Voltage Output	Current Output	Resistive Output	Signal Override Contact	Passive RTD or Thermistor Sensor	592/334 Solid State Sensor
GND	Pwr- & Sig-							Sig-	Sig-	*	** ^	**	***
V+	See spec's												
CH1		CG	X		X	X		Sig+	mA +				
CH2		CG		X	X	X		Sig+	mA+				
CH3		CG/DF* per order			X	X	^^E-POT	Sig+		^^<100KΩ	*E-POT		
CH4		CG/DF* per order			X	X	^^E-POT/^N.O.	Sig+		^^<100KΩ	*E-POT/^N.O.		
TEMP+			Sensor				^^^N.O	~	~		N.O.	Sensor	V+
TEMP-		CG/DF, S1-4**	Sensor				^^^N.O.	~	~		**N.O.	Sensor	***V-

* [CH3] and [CH4] are referenced to [GND] if (CG) is selected at time of order. [CH3] and [CH4] are referenced to each other if (DF) is selected at time of order.

** S1-4, Position (CG) connects [Temp-] terminal to the [GND] terminal internally. The (DF) position makes the [TEMP -] terminal floating. (See Fig.10)

*** This is the current output of the solid state sensor and must be configured as S1-4 set to (DF) to allow the 592 or 334 sensor to operate.

^ The reed contact to override [CH4] can be set up for (CG) which shorts the [CH4] output to [GND] or (DF) shorting the output terminals [CH3/CH4].

^^ The E-POT controls the output resistance setpoint and during override, the E-POT controls the resistance to <100 ohms for 3-5 seconds.

^^^ A reed dry contact across the sensor [TEMP+/-] is configured at time of order as a (-61) option.

~ The [TEMP] terminals are used for an external 10K-2 thermistor connection [EXT option] for display and transmitted output (wire=25' max).

Display Occupancy Termination Mode (Remote Control)

When the override button is pushed, the override output is active for 3 to 5 seconds. Simultaneously, the outline and center of the **HUMAN ICON** on the display will be filled in for 3 to 5 seconds and then go blank.

If you need visual indication of the override on the LCD display, the controller must have a digital output connected to the sensor's three-pin EXT OVR terminal block, J6.

When appropriate power is connected between the EXT OVR common and either 5 VDC or 24 VDC/VAC, both the outline and center of the **HUMAN ICON**

will be filled in. When the external override is canceled, the **HUMAN ICON'S** outline will remain filled in to show that the external override was used.

If power to the sensor is removed, the outline will be blank until the next time the external override is used. *This input is optically isolated from the rest of the device's circuitry.*

Terminal Name	ICON ON 5VDC	ICON ON 24VDC	ICON ON 24VAC
COMMON	-	-	~N
5VDC	+		
24V DC/VAC		+	~H

Table 2: Override Display Termination Table

This [COMMON] is isolated from the other [GND] terminal. See Figures 5 & 6 for more details.

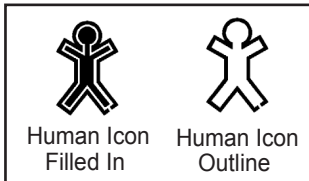

Controller Output OPEN = Controller Output CLOSED (Override) =

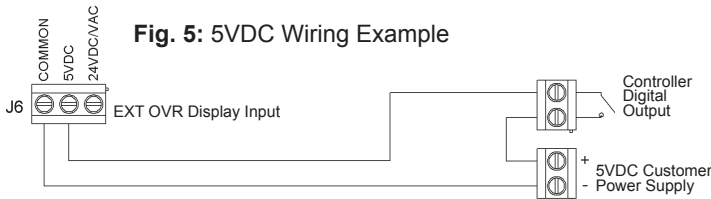

Fig. 5: 5VDC Wiring Example

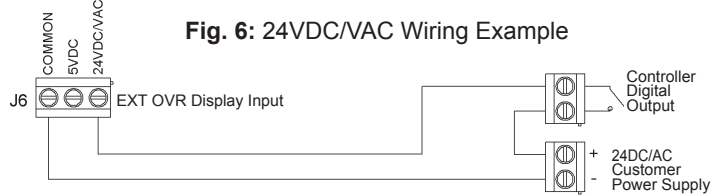
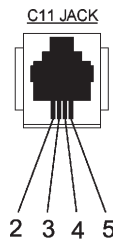

Fig. 6: 24VDC/VAC Wiring Example

Optional Communication Jack Termination Wiring

Fig. 7: C11 Jack



Comm Jack Pin	Wire Color
1	Not Connected
2	Black
3	Red
4	Yellow
5	White or Green
6	Not Connected

Fig. 8: C35 Jack

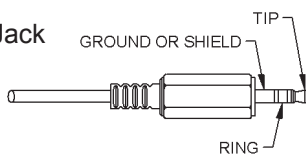

Comm Jack Pin	Wire Color
Ground	White
Tip	Black
Ring	Red

Note: Male Jack shown for clarity

Specifications subject to change without notice.

Fig. 9: View of BAPI-Stat wallplate

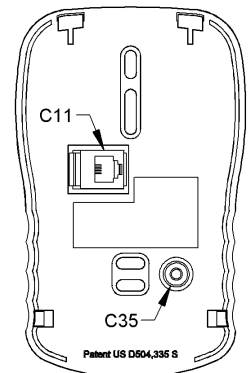

Test & Balance Switch (-TB), (For Passive Sensor Output Only)

Optional Test and Balance Switch (SW1)
(Output at Temp+ and Temp- Terminals)

- Low:** Will set the sensor value low
- Norm:** Thermistor/RTD will operate normally
- High:** Will set the sensor value high

Consult Factory for Additional Details

Sensor Type	Low Temperature (40° F)	High Temperature (105° F)
	Resistance Value	Resistance Value
1000 RTD	1.02K (41.2°F)	1.15K (101.5°F)
3000 Thermistor	7.87K (39.8°F)	1.5 (106.8°F)
10K-2 Thermistor	30.1K (34.9°F)	4.75K (109.1°F)
10K-3 Thermistor	26.7K (35.9°F)	5.11K (108.4°F)
10K-3(11K) Thermistor	7.32K (43.7°F)	3.65K (105.2°F)

Specifications subject to change without notice.

Optional Technician Adjustments

The four DIP switches on the bottom of the board called S1 configure four different parameters (see Fig: 10).

- 1) Fahrenheit or Celsius temperature display "F/C" Switch.
- 2) Display Reading Offset "Mode" Switch for temperature and humidity appearance and output offset.
- 3) User Setpoint Lockout Enable "SPLO" Switch.
- 4) Passive temperature sensor differential ground or common ground configuration "TEMP" Switch.

ADJUSTMENT PROCEDURE FOR EACH DIP SWITCH IN S1:

°F OR °C DISPLAY SELECTION [F/C Switch]

The "F/C" Switch allows for either °F or °C operation. Remove the cover from the backplate and set the switch to the desired position.

DISPLAY READING OFFSET [MODE Switch]

The Display Reading Offset "Mode" Switch lets you adjust the reading of the BAPI-Stat display. For example if the display reads 70° but you wish it to display and send a signal to your controller of 70.5°, you will enter an adjustment of 0.5. If the display reads 40 %RH and you wish it to display and send a signal to your controller of 38% RH, you will enter -2.0.

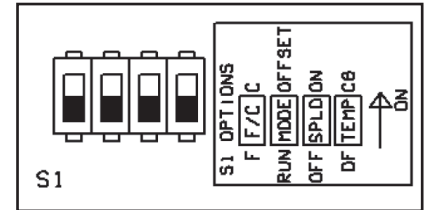

Fig. 10: Configuration Switches S1

- 1) Remove cover from backplate & slide the "MODE" switch on S1 to the "OFFSET" position. The screen in figure 11 will appear on the display. If you previously entered an offset, the offset you entered will show on the display. Either the F or C annunciator will be lit depending on the position of "F/C" Switch
- 2) Press the Override button on the front of the sensor to advance to the screen for the parameter you wish to change.
 - a. TEMPERATURE OFFSET - Screen P26 (figure 11)
 - b. HUMIDITY OFFSET - Screen P27 (figure 12)
 - c. DISPLAY MODE - Screen P28 (figure 13)
 - d. ACTIVE TEST & BALANCE MODE - Screen P29 (figures 14 & 15)
- 3) Use the Temperature Setpoint up and down arrows on the front of the sensor to select the calibration needed.
 - a. TEMPERATURE OFFSET - Adjust the temperature $\pm 5^\circ$ in 0.1° increments
 - b. HUMIDITY OFFSET - Adjust the humidity $\pm 5\%$ in 0.1% increments
 - c. DISPLAY MODE - Adjust to 0 through 7 depending on the display mode you desire.
 - 0 - Temperature in the main portion and %RH in the upper section
 - 1 - %RH in the main portion and Temperature in the upper section
 - 2 - The LCD toggles the locations at a ~5 second rate
 - 3 - Temperature Only.
 - 4 - Setpoint Display Only (SDO), Temp Setpoint in the main portion and %RH Setpoint in the upper section
 - 5 - Setpoint Display Only (SDO), %RH Setpoint in the main portion and Temp Setpoint in the upper section
 - 6 - Setpoint Display Only (SDO), The LCD toggles the setpoints between the locations at a ~5 second rate
 - 7 - Setpoint Display Only (SDO), Temperature Setpoint only.
 (Note: Selecting options 1, 2, 5 or 6 with units without %RH will default to mode 0)
 - d. ACTIVE TEST & BALANCE MODE - Toggles between 'LO' and 'HI' on the LCD. This mode is active only for models which use Channel 1 as a temperature output. 'LO' will drive Channel 1 to it's lowest voltage or current output. 'HI' will drive Channel 1 to it's highest voltage or current output. (figures 14 & 15)
- 4) Press the Override button on the front of the sensor to 'enter' and store the change. Set the "MODE" switch on S1 back to "RUN" and put the cover on the backplate.

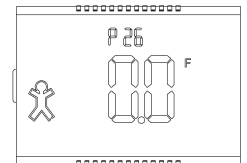

Fig. 11: Temp Offset

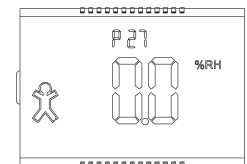

Fig. 12: %RH Offset

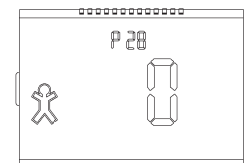

Fig. 13: Display Mode

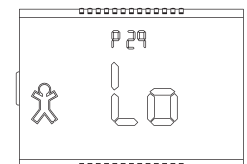

Fig. 14: T&B Mode Lo

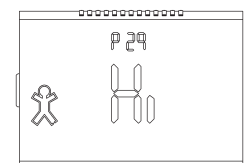

Fig. 15: T&B Mode Hi

SETPOINT LOCK OUT [SPLO Switch]

The "SPLO" Switch allows the setpoint buttons to be disabled. A switch setting of "ON" disables the buttons.

PASSIVE TEMPERATURE SENSOR GROUNDING [TEMP switch]

Adjust DIP switch to "CG" for [TEMP -] connected to common ground [GND]

Adjust DIP switch to "DF" for [TEMP -] differential floating without connection to any ground.



“BAPI-Stat” – 3 Button Unit with External Sensor

Installation & Operating Instructions

15641_ins_bs_remote_sens

rev.07/02/15

Diagnostics

POSSIBLE PROBLEMS

General Diagnostics

POSSIBLE SOLUTIONS:

- Determine that the input is set up correctly in the controller’s and building automation software.
- Check wiring for proper termination
- Check for corrosion at either the controller or the sensor. Clean off the corrosion, re-strip the interconnecting wire and reapply the connection. In extreme cases, replace the controller, interconnecting wire and/or sensor.
- Label the terminals that the interconnecting wires are connected to at the sensor end and the controller end. Disconnect the interconnecting wires from the controller and the sensor. With the interconnecting wires separated at both ends measure the resistance from wire-to-wire with a multimeter. The meter should read greater than 10 Meg-ohms, open or OL depending on the meter you have. Short the interconnecting wires together at one end. Go to the other end and measure the resistance from wire-to-wire with a multimeter. The meter should read less than 10 ohms (22 gauge or larger, 250 feet or less). If either test fails, replace the wire.

Unit does not operate

- Check power for proper polarity.
- Disconnect the power wires at the controller. Measure controller output for proper power (see specifications), if the voltage is outside the limits trouble shoot controller. Reconnect power wires to controller when finished. If the measured voltage is above the specification limit, you may have damaged the BAPI-Stat, contact your BAPI representative.
- Disconnect the power wires at the sensor. Measure the wires for the same voltage as at controller. If the voltage is different from that measured at the controller troubleshoot wire. Reconnect power wires to sensor when finished.
- Measure the power at the sensor with the power connected for proper power (see specifications), if the voltage is outside the specification limits call your BAPI representative.

If you need more help troubleshooting a BAPI-Stat problem, see the BAPI-Stat Advanced Troubleshooting Guide document on the BAPI-Stat page on our website at www.bapihvac.com

Specifications subject to change without notice.