



Overview

Many times you need to place only one communications repeater at a specific point in a communications network. A four-position Communications Repeater Backplane (RBP4) and its associated power supplies is clearly overkill. The BAPI SRBP - Single Repeater Back Plane teamed with a BAPI VC350 voltage converter (in Accessories section) and a FOX, SOX or RPTR module provides a convenient single repeater solution.

The SRBP fits into the standard 2.75" snaptrack. Pluggable connectors on the face of the SRBP allow quick and easy connections for power and RS-485 communications buses. One FOX, SOX or RPTR module plugs into a mating connector. Built-in surge suppression protects the network and power connections.

The SRBP receives 12VDC power from either a 3324VC or a BAPI VC350 voltage converter (shown in the Accessories section).

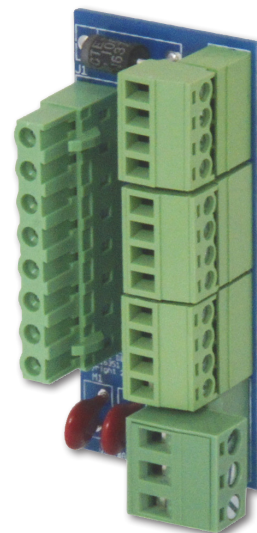

SRBP - Single Repeater Backplane

Part Number	Description	List Price
BA/SRBP	Single Repeater Backplane	\$50
BA/SRBP-TRK	SRBP with 2" piece of 2.75" snaptrack	\$56

Submittal datasheets without List Prices are available on our website at www.bapihvac.com

Associated Products

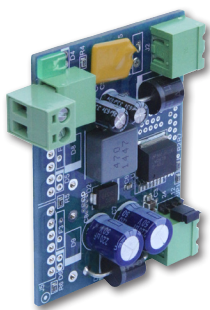

3324VC Voltage Converter
(p. H8)

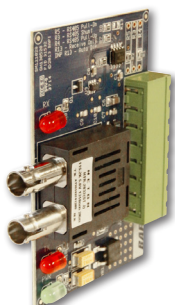

SOX - RS-485 Fiber Optic Transceiver
(p. H26)

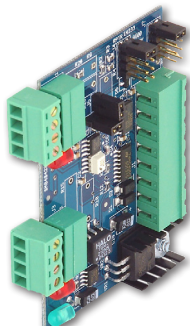

RPTR - RS-485 Repeater
(p. H22)

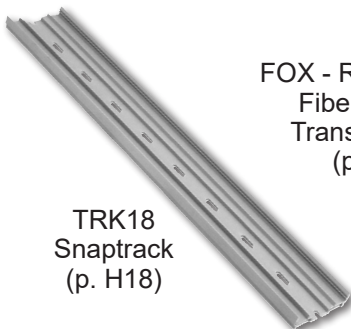

TRK18 Snaptrack
(p. H18)

FOX - RS-485 Fiber Optic Transceiver
(p. H24)

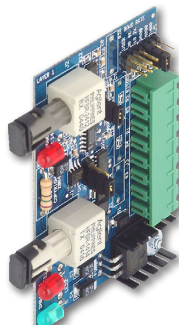

Specifications

SRBP - Single Repeater Backplane mounted in the optional 2.75" snaptrack

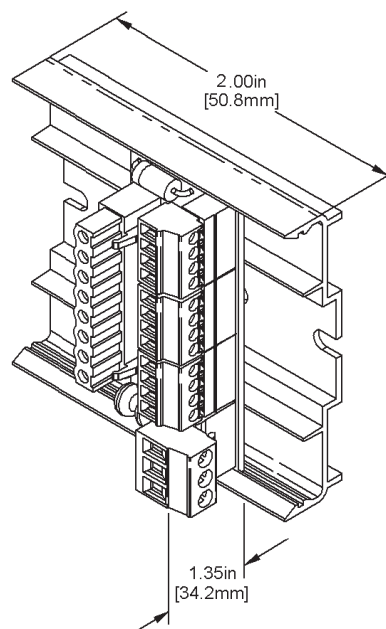

Power Voltage: 12 VDC

Power Current: 250mA max.