



Resistance Output Module (ROM)

B27

Humidity & Combination Temp/Humidity Sensors

Rev. 12/08/10

Resistance Output Module (ROM) Overview

The Resistance Output Module (ROM) converts the Temperature data from the Washdown Wall Plate into a Resistance for the DDC controller. The unit is factory calibrated to output a 10K-2, 10K-3, 10K-3(11K) or 20K thermistor curve or a 25K to 75K linear curve. It features 2.75" snaptrack, 35MM din rail or surface mounting. Includes the "Resistive Output" pluggable terminal block connector.

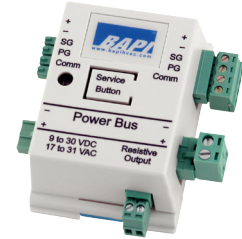

Resistance Output Module - ROM
(Includes the Resistive Output terminal block connector only)

PART NUMBERS:

BA/ROM-102-EZ	10K-2 thermistor curve)
BA/ROM-103-EZ	10K-3 thermistor curve)
BA/ROM-10311-EZ	10K-3(11K) thermistor curve
BA/ROM-20	20K thermistor curve
BA/ROM-91	25K to 75K linear curve

(See pages 30-31 for pricing)

Analog Output Module (AOM) Accessories

Analog Output Modules (AOMs), such as the Resistance Output Module, are connected to a Washdown Wall Plate Power Supply (shown on page B18) and receive the temperature or humidity data through a four-wire bus. Up to 30 different AOMs can be connected to a single Power Supply; therefore one Power Supply can power up to 15 different Wall Plates. Each AOM is easily trained to a specific Wall Plate signal with a pushbutton and LED. The modules are surface, 2.75" snaptrack or 35mm din rail mountable.

AOMs plug into each other or a Washdown Wall Plate Power Supply as shown in the top picture at right. However, the AOMs may also be mounted remotely using the optional Pluggable Terminal Block Connectors which are available as a 4-connector kit.

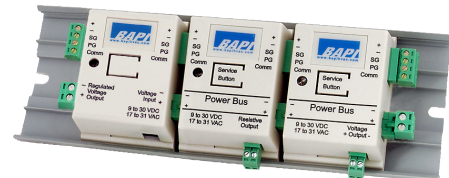

Washdown Power Supply with two Output Modules

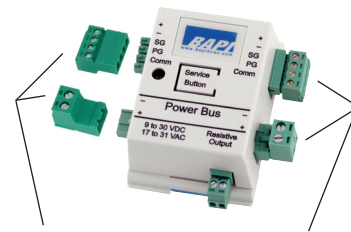

Optional Pluggable Terminal Block Kit for AOMs (4 Connectors)

PART NUMBER:

BA/AOM-CONN - Pluggable Terminal Block Kit for AOMs (includes 4 terminal block connectors, see image at right)

Specifications for Resistance Output Module

Supply Power: 9 to 30 VDC or 17 to 31 VAC

Power Consumption: 3 mA max. DC, .1 VA max AC

Bus Cable Distance:

4,000 ft with shielded, twisted pair cable (Belden 9841, Belden 8132 or equivalent)

Output Resolution: ~40 Ohms

Analog Input Bias Voltage: 5 VDC max

Environmental Operation Range:

Temp: 0° to 60°C
Humidity: 5% to 95% RH non-condensing

Material: ABS Plastic

Material Rating: UL94, V-0

Temp. Output Ranges at ~0.5°F Resolution:

10K-2 Unit: 35°F to 120°F (1°C to 50°C)

10K-3 Unit: 32°F to 120°F (0°C to 50°C)

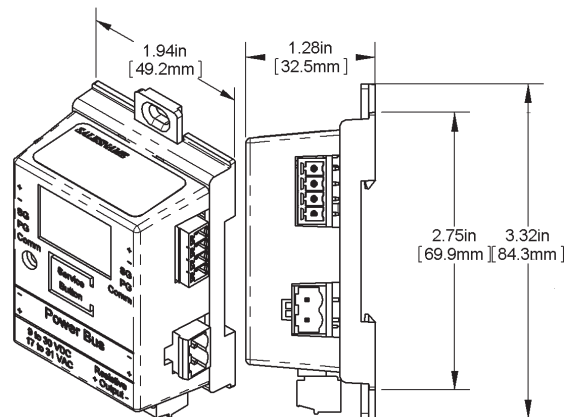

Resistance Output Module

**Washdown Wall Plate Power Supply
BA/VPS-EZ**

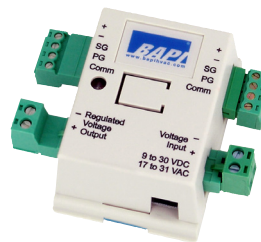

<u>PART NUMBERS</u>	<u>DESCRIPTION</u>	<u>LIST PRICE</u>
BA/VPS-EZ	Washdown Wall Plate Power Supply (Includes all four pluggable terminal block connectors)	\$75

Resistance Output Module (ROM)

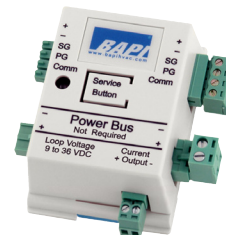

<u>PART NUMBERS</u>	<u>DESCRIPTION</u>	<u>LIST PRICE</u>
BA/ROM-102-EZ	Resistance Output Module, 10K-2 thermistor curve	\$150
BA/ROM-103-EZ	Resistance Output Module, 10K-3 thermistor curve	\$150
BA/ROM-10311-EZ	Resistance Output Module, 10K-3(11K) thermistor curve	\$150
BA/ROM-20	Resistance Output Module, 20K thermistor curve	\$150
BA/ROM-91	Resistance Output Module, 25K to 75K linear curve	\$150

Terminal Block Connectors for Analog Output Module

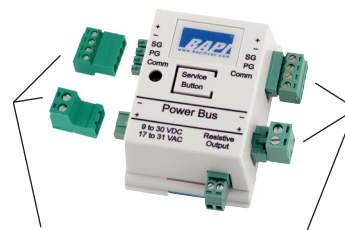

Pluggable Terminal Block Kit for AOMs (includes 4 Connectors)

<u>PART NUMBERS</u>	<u>DESCRIPTION</u>	<u>LIST PRICE</u>
BA/AOM-CONN	Pluggable Terminal Block Connectors for Analog Output Modules (includes 4 terminal block connectors, see image above)	\$15